



Republic of the Philippines  
GENERAL SANTOS CITY WATER DISTRICT  
E. Fernandez Street, Barangay Lagao General Santos  
Telephone No.: 552-3824; Telefax No.: 553-4960  
Email Address: gscwdprocurement@yahoo.com

GPM-014-2

### REQUEST FOR QUOTATION

RFQ #: 3-0822-071      DATE: 08/22/2022

SUPPLIER: \_\_\_\_\_  
ADDRESS: \_\_\_\_\_  
TELEPHONE NO. : \_\_\_\_\_  
TIN NO. : \_\_\_\_\_

Dear Sir/Madam,

Pls. quote your lowest price on the item/s listed below subject to general condition stating the shortest time of delivery and submit your quotation duly signed by your representative not later than 08/26/2022, Pls. furnish this office the following articles subject to the terms and conditions contained therein.

ITEM NO.	DESCRIPTION	QTY.	UNIT	UNIT PRICE
1	FABRICATION OF STEEL FLANGE 700MM : ABC: PHP 45,000.00	1	pc	P
2	FABRICATION OF STEEL FLANGE 485MM : ABC: PHP 22,000.00	1	unit	P
3	FABRICATION OF STEEL FLANGE 405MM : ABC: PHP 37,000.00 ##### nothing follows #####	2	pc	P

Date of Delivery: \_\_\_\_\_  
Price Validity : \_\_\_\_\_  
Terms of Payment: \_\_\_\_\_

Place of Delivery: GSCWD Bodega

\*\*\*\*\*No partial delivery allowed\*\*\*\*\*

Note: 6% WITHHOLDING TAX DEDUCTION

PR NO.: 0822-020

Requested by:

**GESEM R. CABAÑERO**  
MATERIAL PROCUREMENT  
OFFICER A

Price quoted by:

\_\_\_\_\_  
Supplier

\_\_\_\_\_  
Date

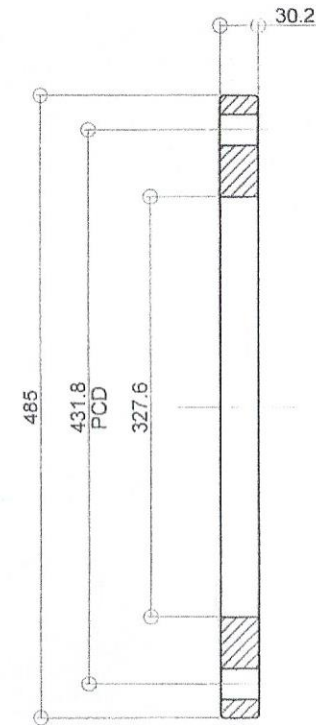
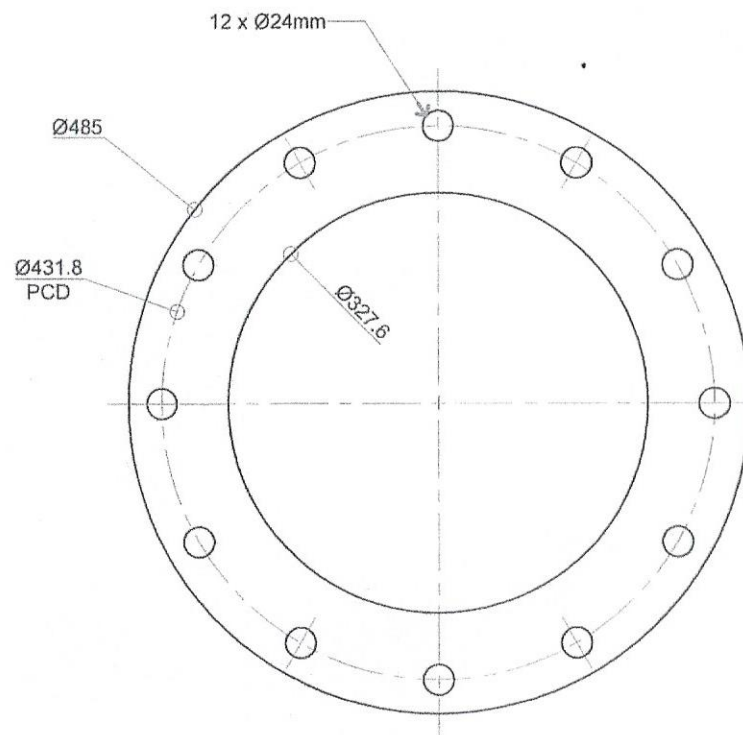

FOR: STEEL REDUCER FLANGE TYPE

PLAN

SECTION

 <p><b>GENERAL SANTOS CITY WATER DISTRICT</b> E. FERNANDEZ STREET, BRGY. LAGAO, GEIL SANTOS CITY ENGINEERING &amp; CONSTRUCTION DEPARTMENT PLANNING AND DESIGN DIVISION TEL. NO. (083) 552-3824</p>	MATERIALS DESCRIPTION:	PREPARED BY:	CHECKED BY:	APPROVED BY:	CONTENT:			
	SHOP DRAWING OF 300mmØ STEEL FLANGE	REY R. ANORA ENGINEERING AID A	ENGR. MA. CELIA N. DANDAN OFFICER IN CHARGE, PDD	ENGR. ROGELIO A. BESANA, JR. ACM, OPERATION & TECHNICAL SERVICES	<p><b>AS SHOWN</b></p> <table border="1"> <tr> <td>DRAWN: RRA</td> <td>REVISION:</td> </tr> <tr> <td>CHECKED:</td> <td>DATE:</td> </tr> </table>	DRAWN: RRA	REVISION:	CHECKED:
DRAWN: RRA	REVISION:							
CHECKED:	DATE:							

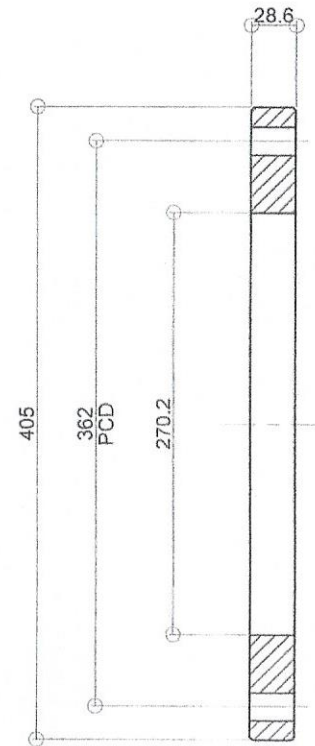
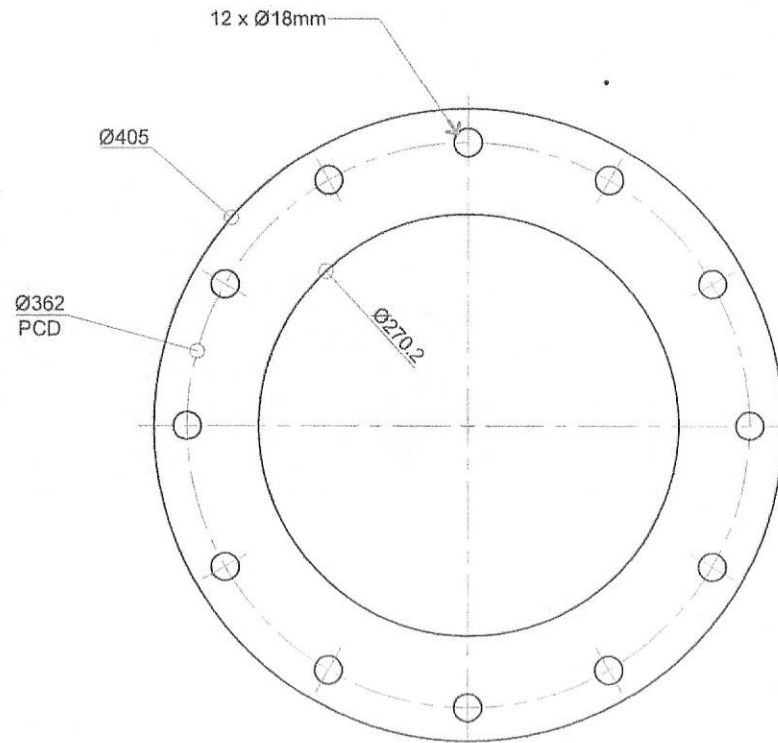

FOR: STEEL REDUCER FLANGE TYPE

PLAN

SECTION

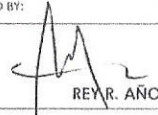
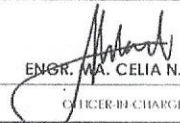
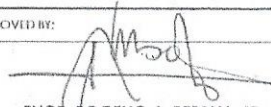
 <p><b>GENERAL SANTOS CITY WATER DISTRICT</b> E. FERNANDEZ STREET, BRGY. LAGAO, GEN. SANTOS CITY ENGINEERING &amp; CONSTRUCTION DEPARTMENT PLANNING AND DESIGN DIVISION TEL. NO.: (083) 552-3824</p>	MATERIALS DESCRIPTION:	PREPARED BY:	CHECKED BY:	APPROVED BY:	CORRECTION:	
	SHOP DRAWING OF 250mmØ STEEL FLANGE	 <b>REY R. ANORA</b> ENGINEERING AID I/A	 <b>ENGR. CELIA N. DANDAN</b> OFFICER-IN-CHARGE, PDD	 <b>ENGR. ROGELIO A. BESANA, JR.</b> AGM, OPERATION & TECHNICAL SERVICES	<b>AS SHOWN</b> DRAWN: RRA    REVI: BVI CHECKED:    DAB	

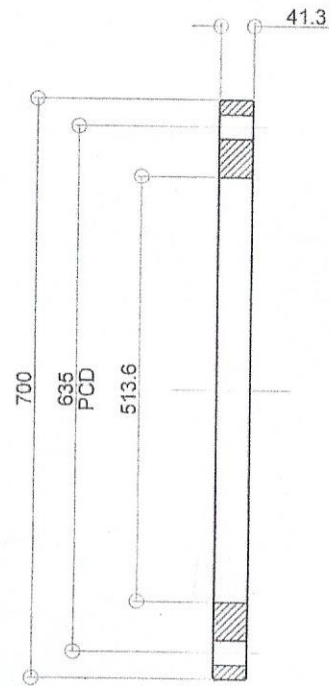
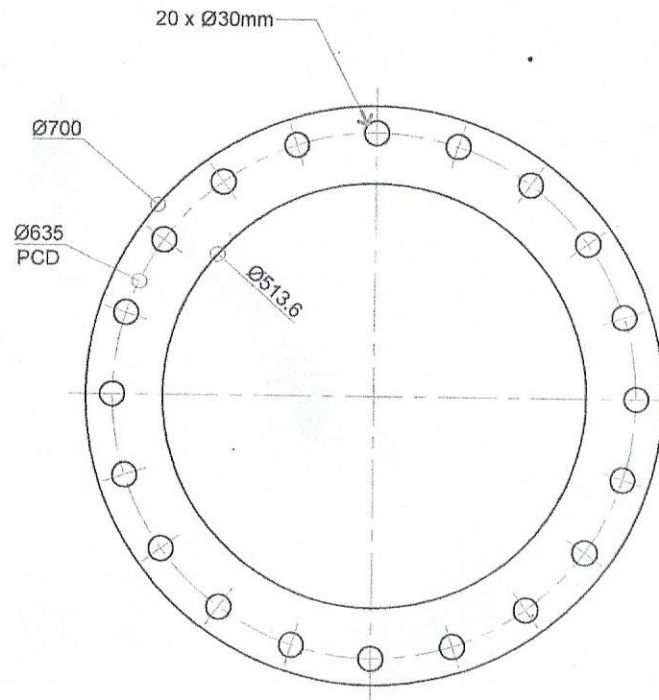

FOR: STEEL REDUCER FLANGE TYPE

PLAN

SECTION

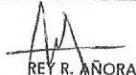
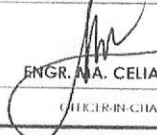
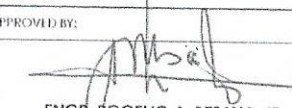
 <p><b>GENERAL SANTOS CITY WATER DISTRICT</b> E. FERNANDEZ STREET, BINGY, LAGAO, GEN. SANTOS CITY ENGINEERING &amp; CONSTRUCTION DEPARTMENT PLANNING AND DESIGN DIVISION TEL. NO.: (083) 552-3824</p>	MATERIALS DESCRIPTION:	PREPARED BY:	CHECKED BY:	APPROVED BY:	CORRECTION:
	SHOP DRAWING OF 500mmØ STEEL FLANGE	 <b>REY R. ANORA</b> ENGINEERING AIDE A	 <b>ENGR. M.A. CELIA N. DANDAN</b> CHIEF-IN-CHARGE, PDD	 <b>ENGR. ROGELIO A. BESANA, JR.</b> AGM, OPERATION & TECHNICAL SERVICES	<b>AS SHOWN</b> DRAWN: RRA    REVISION: CHECKED:    DATE: A